

autokey.com.ua

DENSO AIRBAG MODULE

READING WITHOUT MCU DESOLDERING

How to use

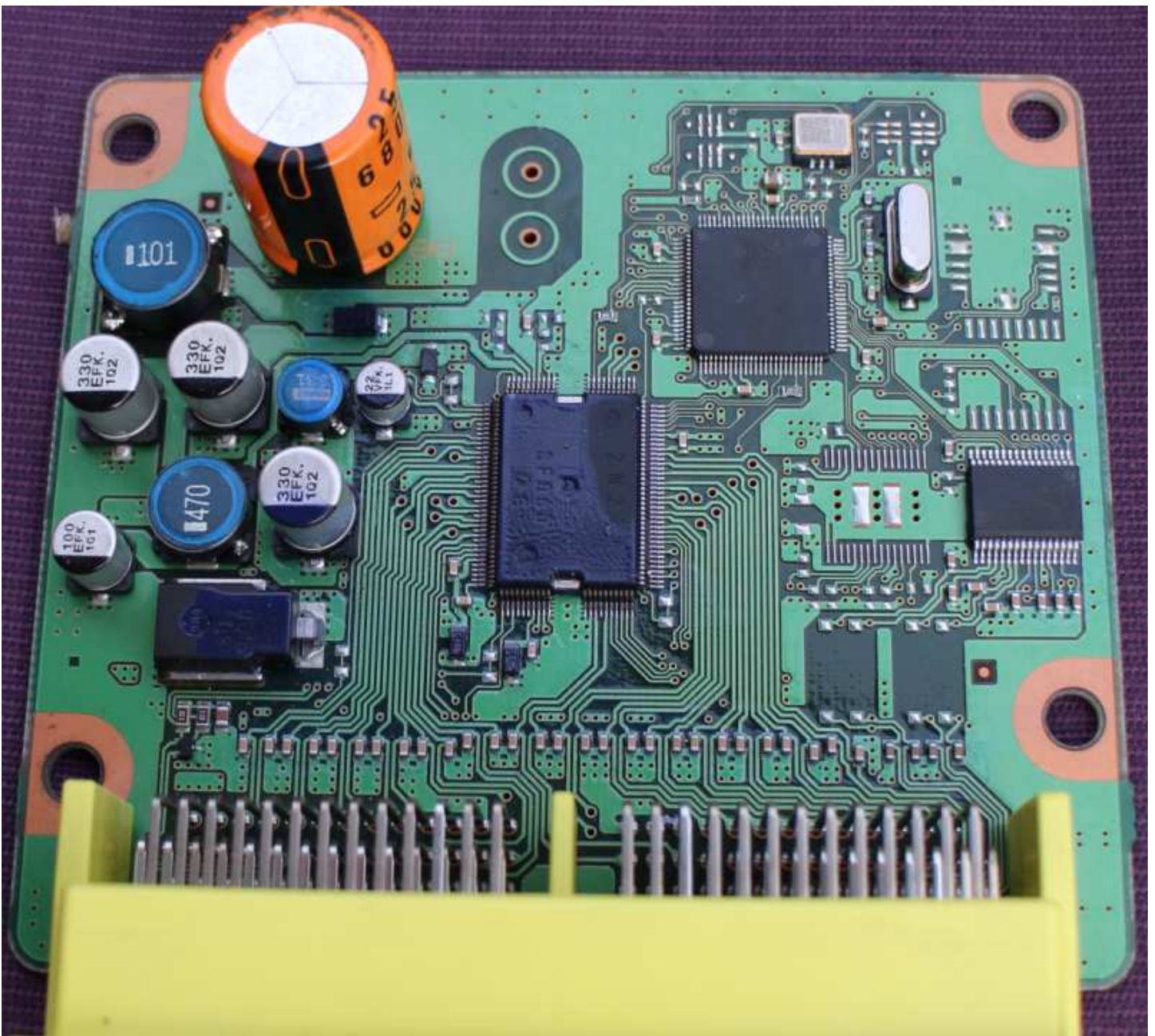

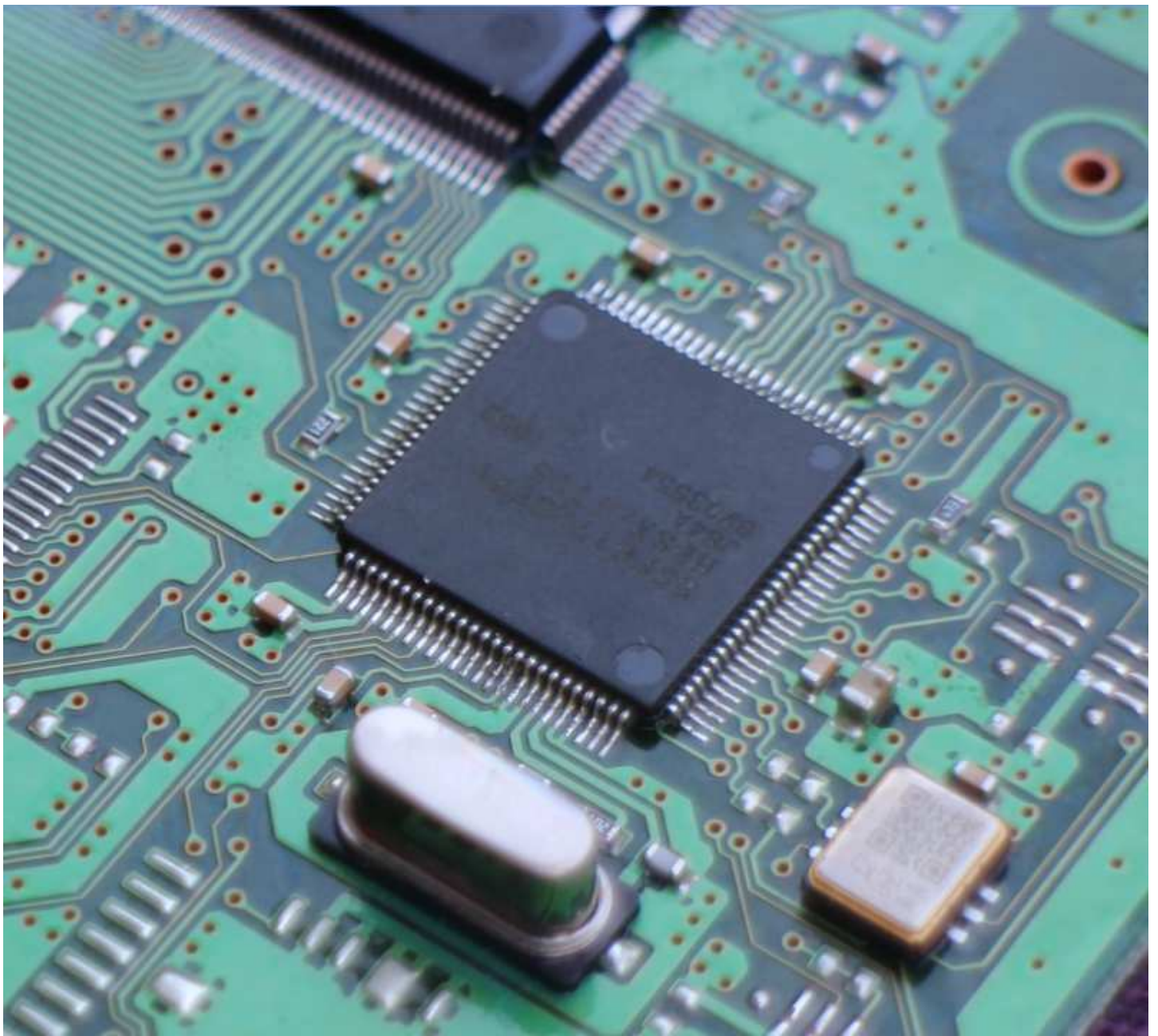

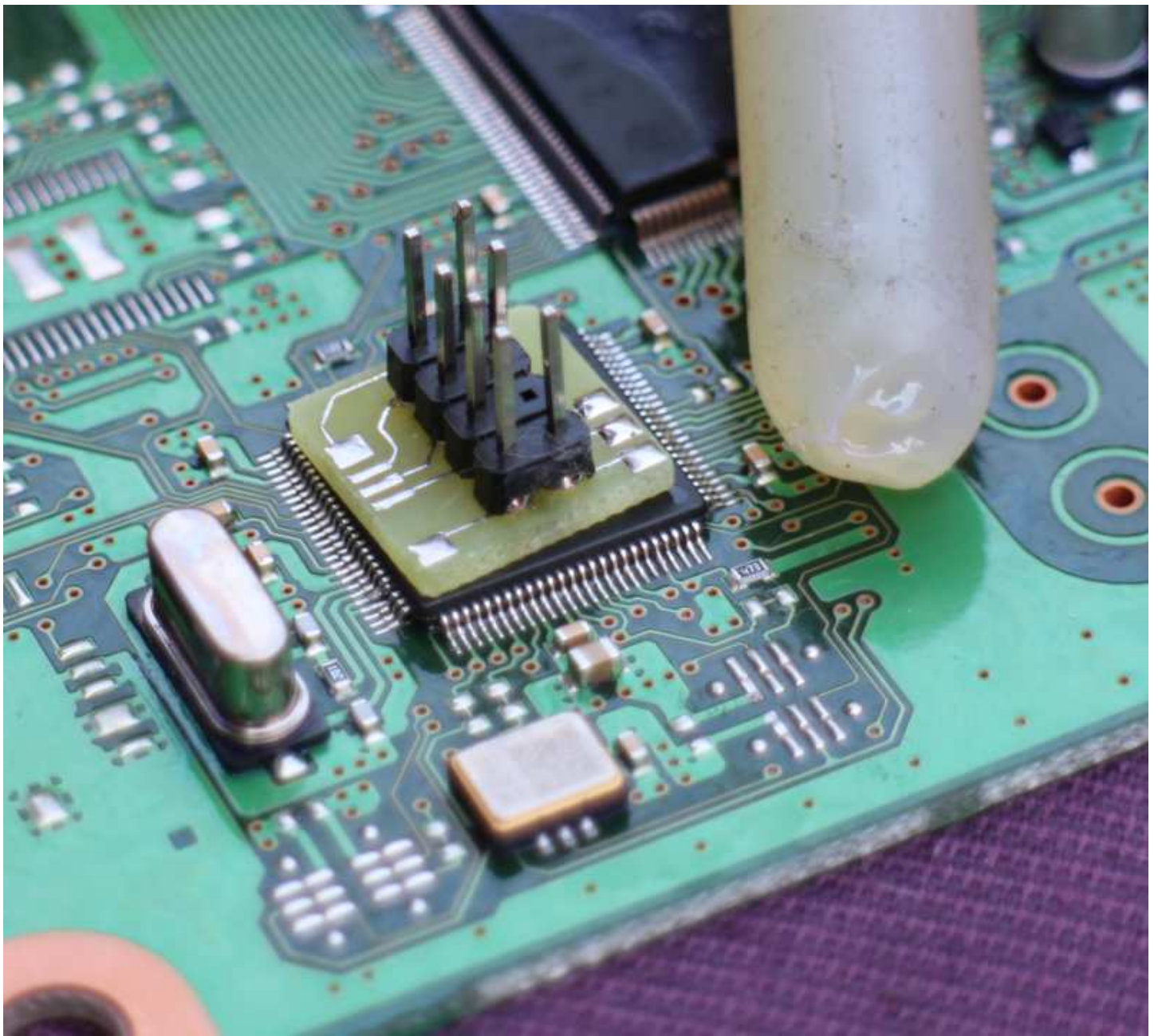

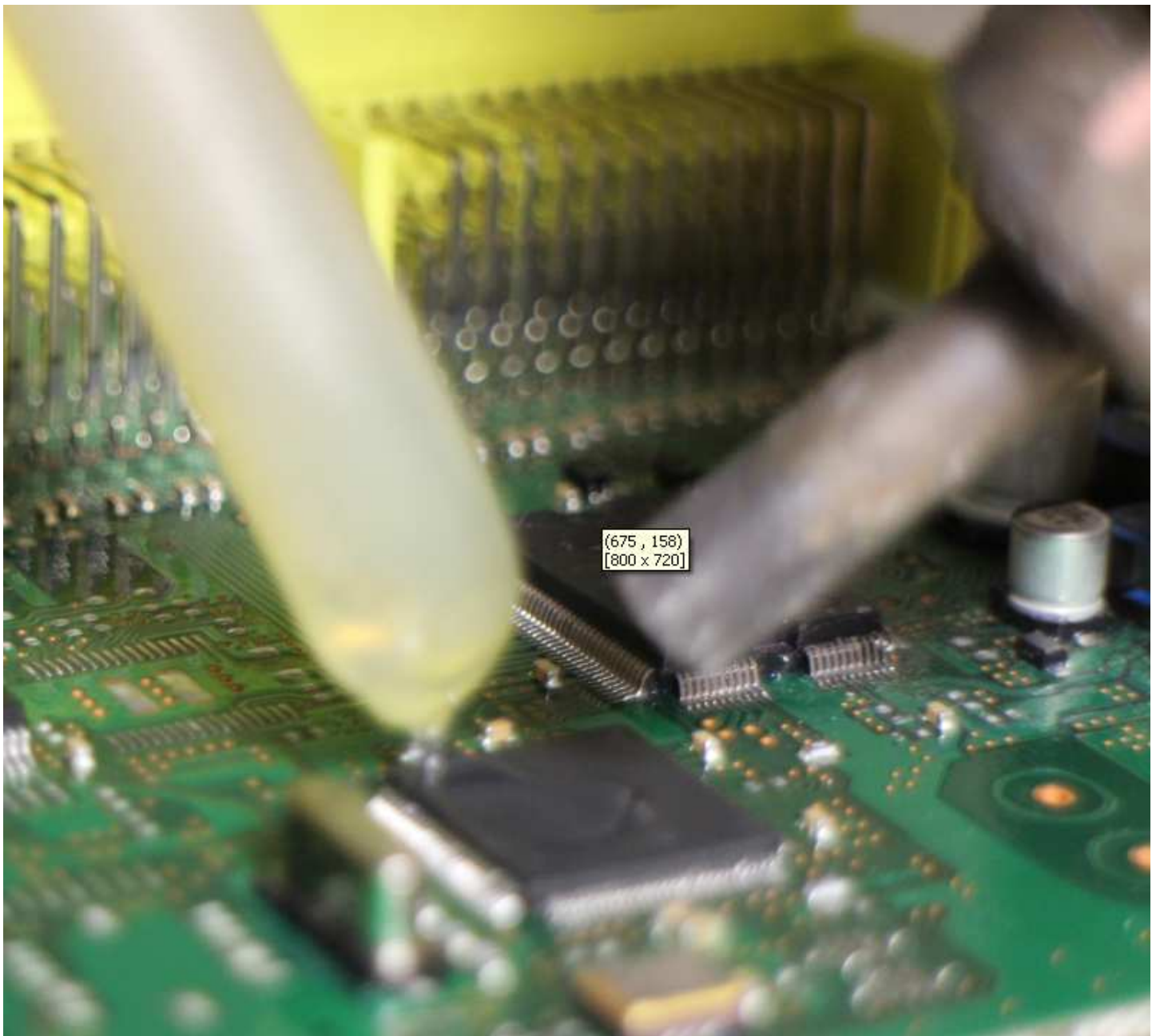

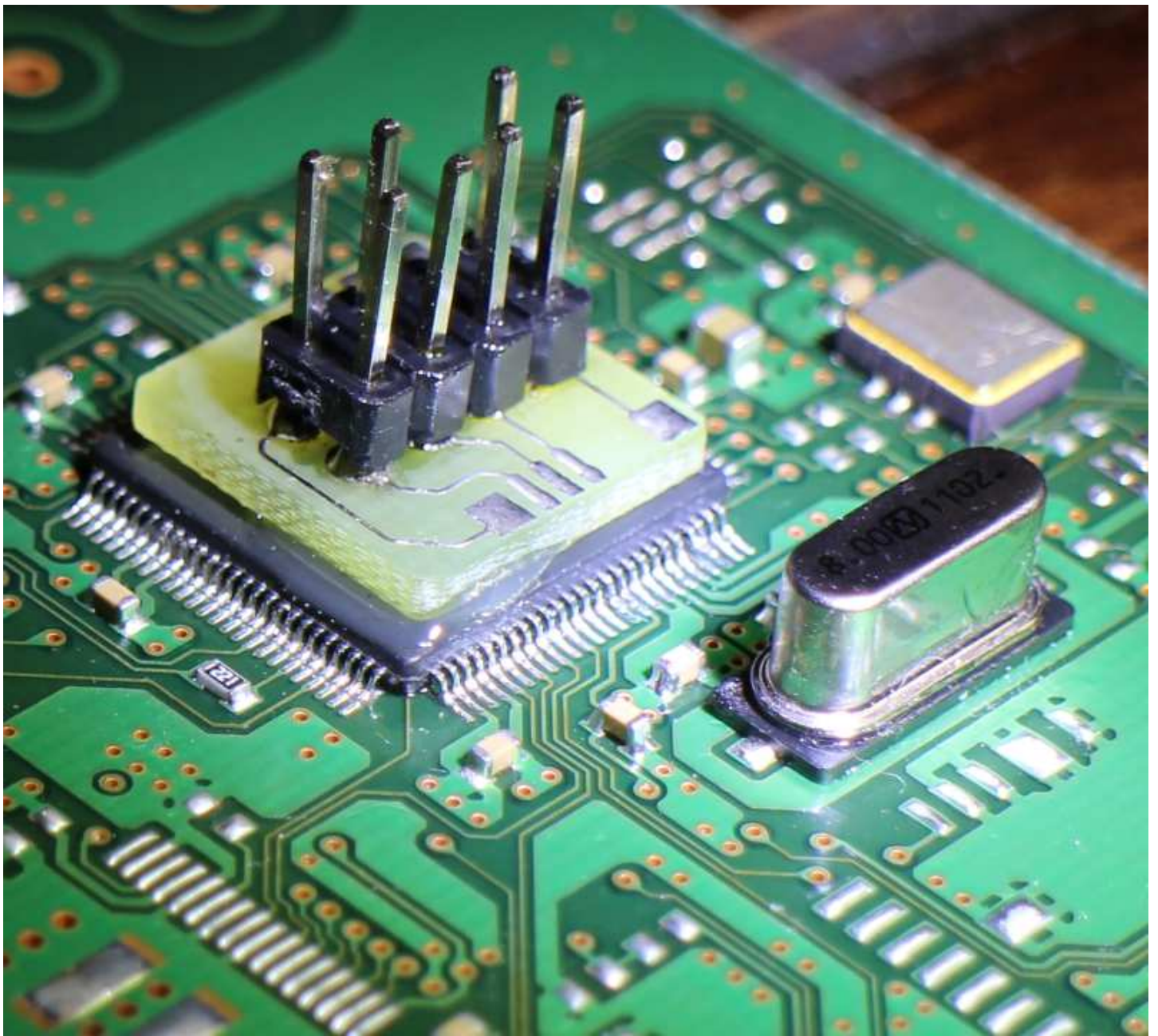

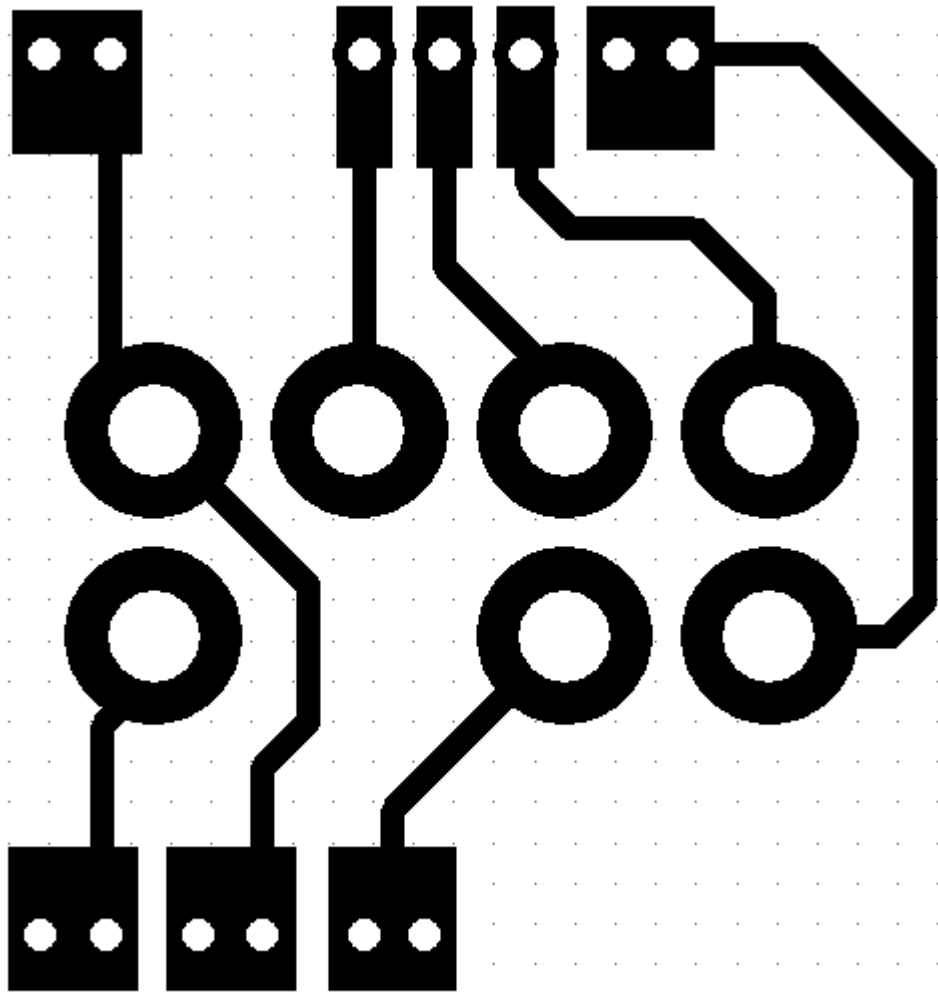

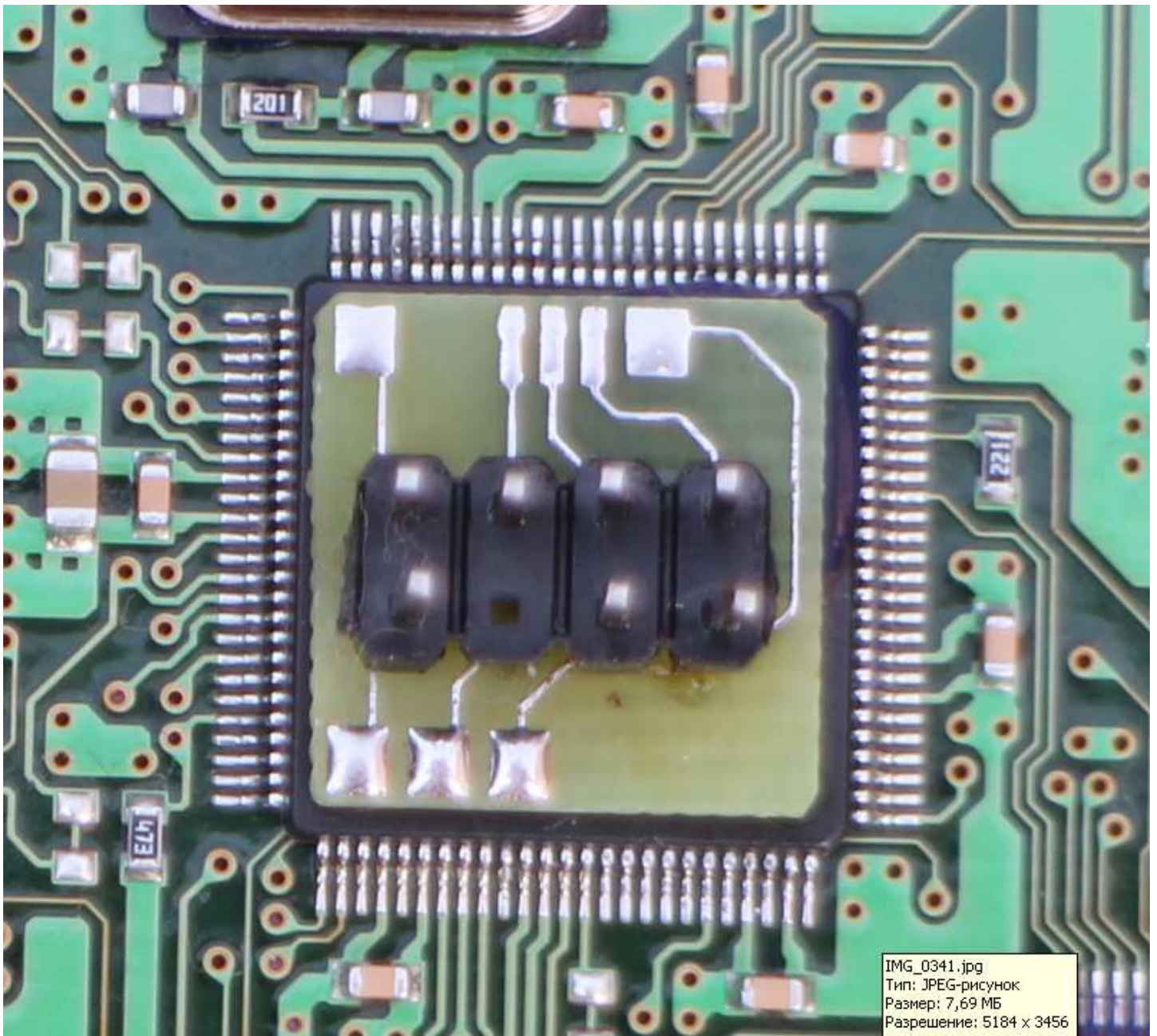

IMG_0341.jpg
Тип: JPEG-рисунок
Размер: 7,69 МБ
Разрешение: 5184 x 3456

DISCONNECT FROM PCB

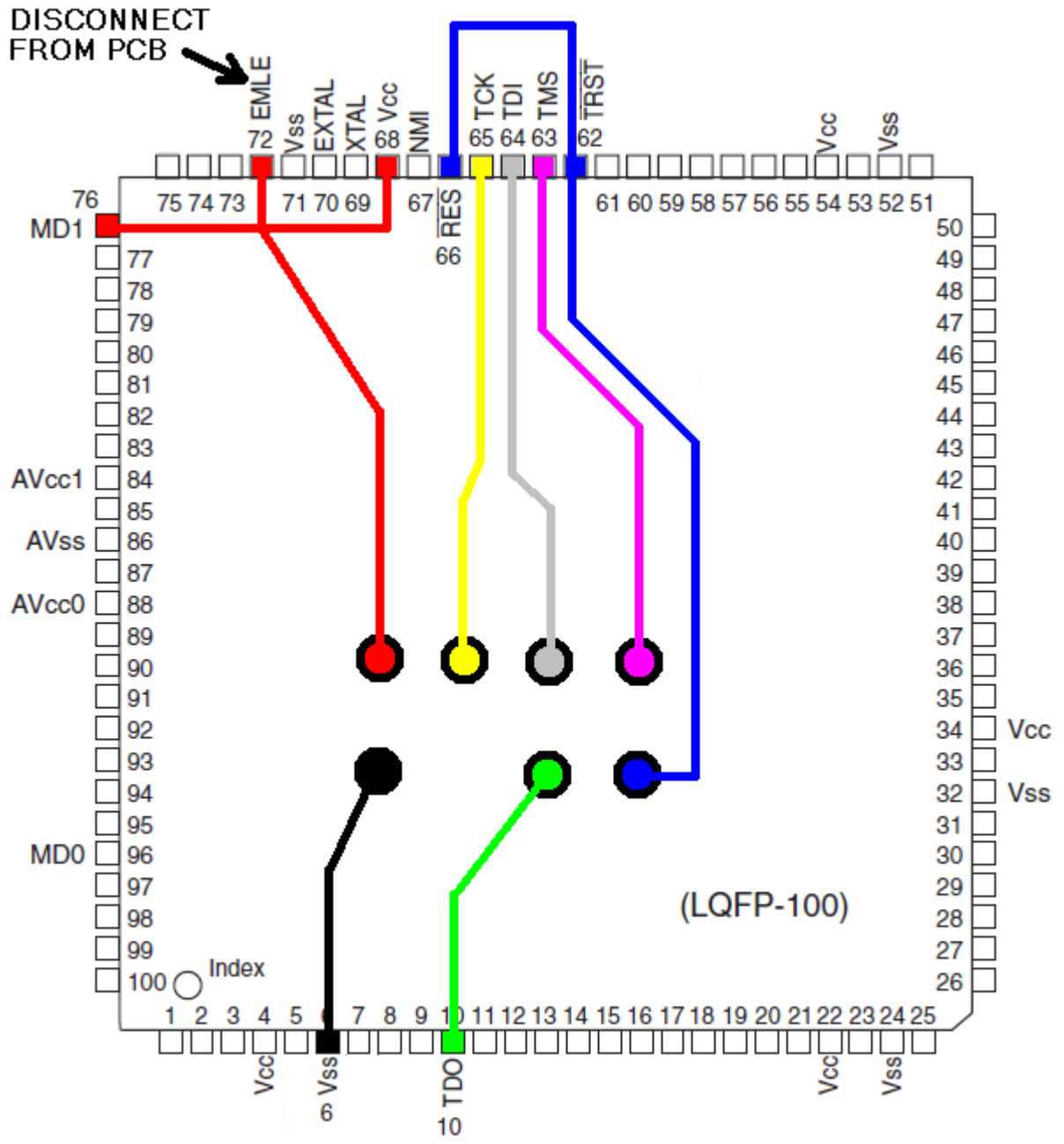

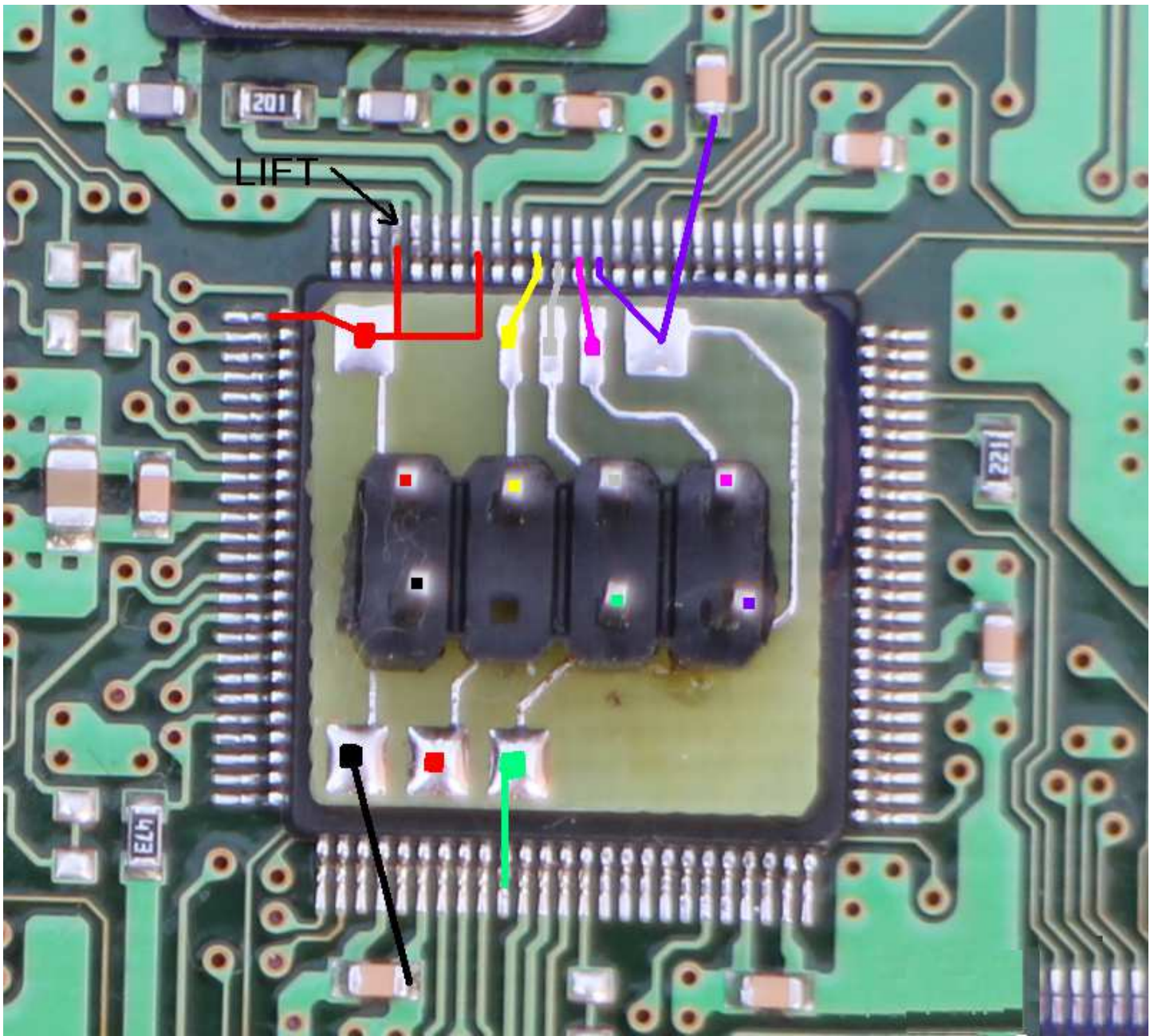

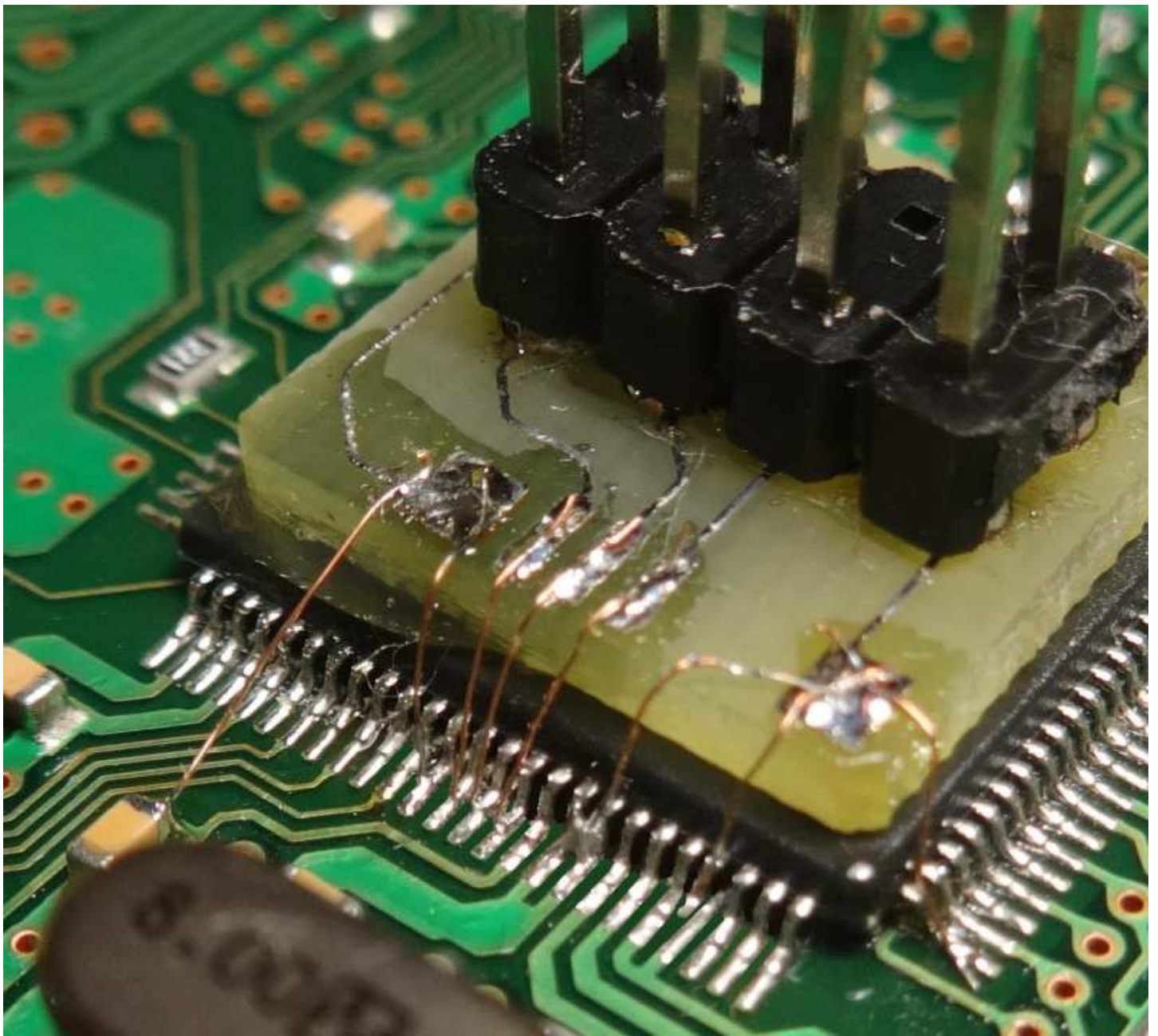

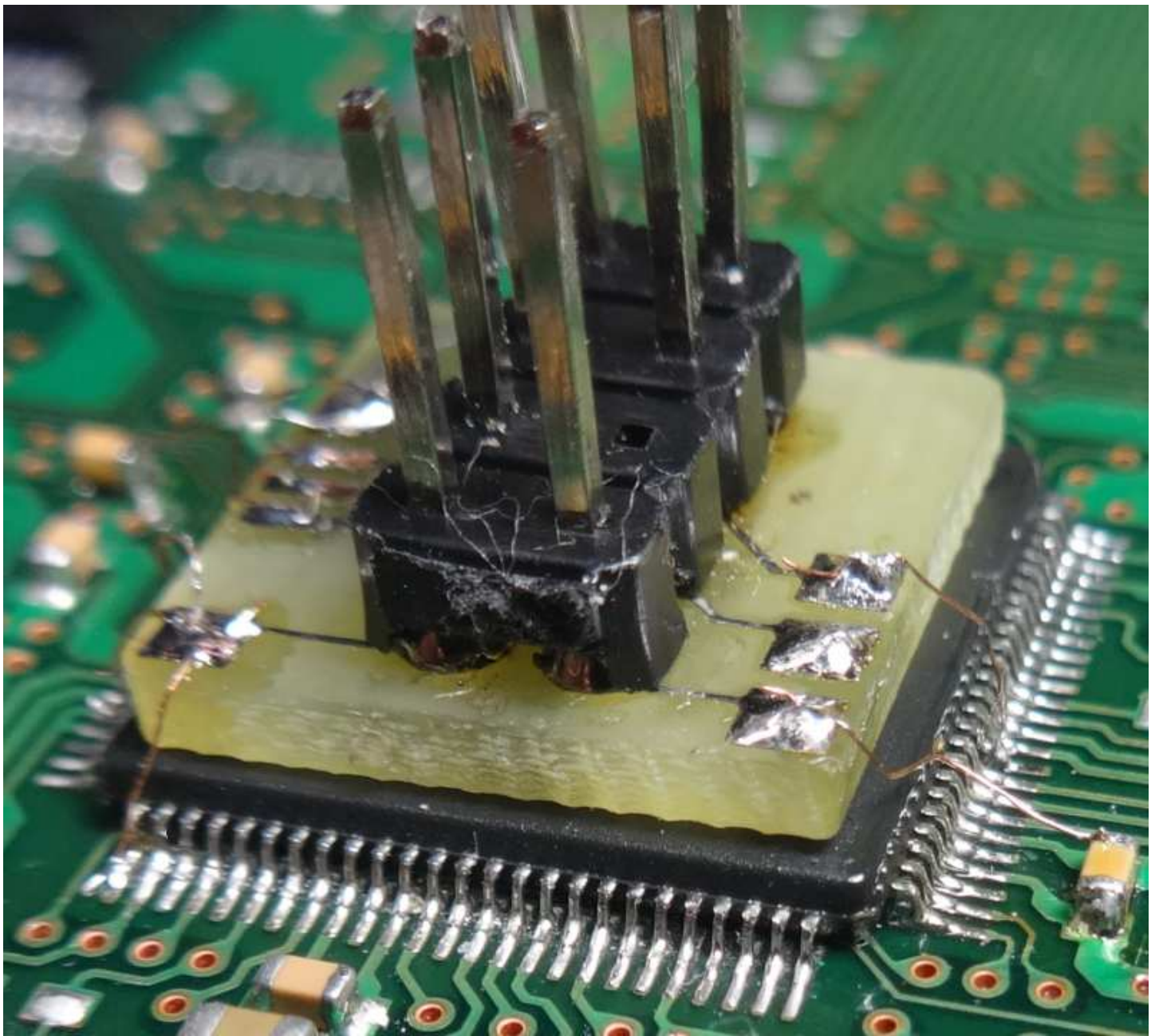

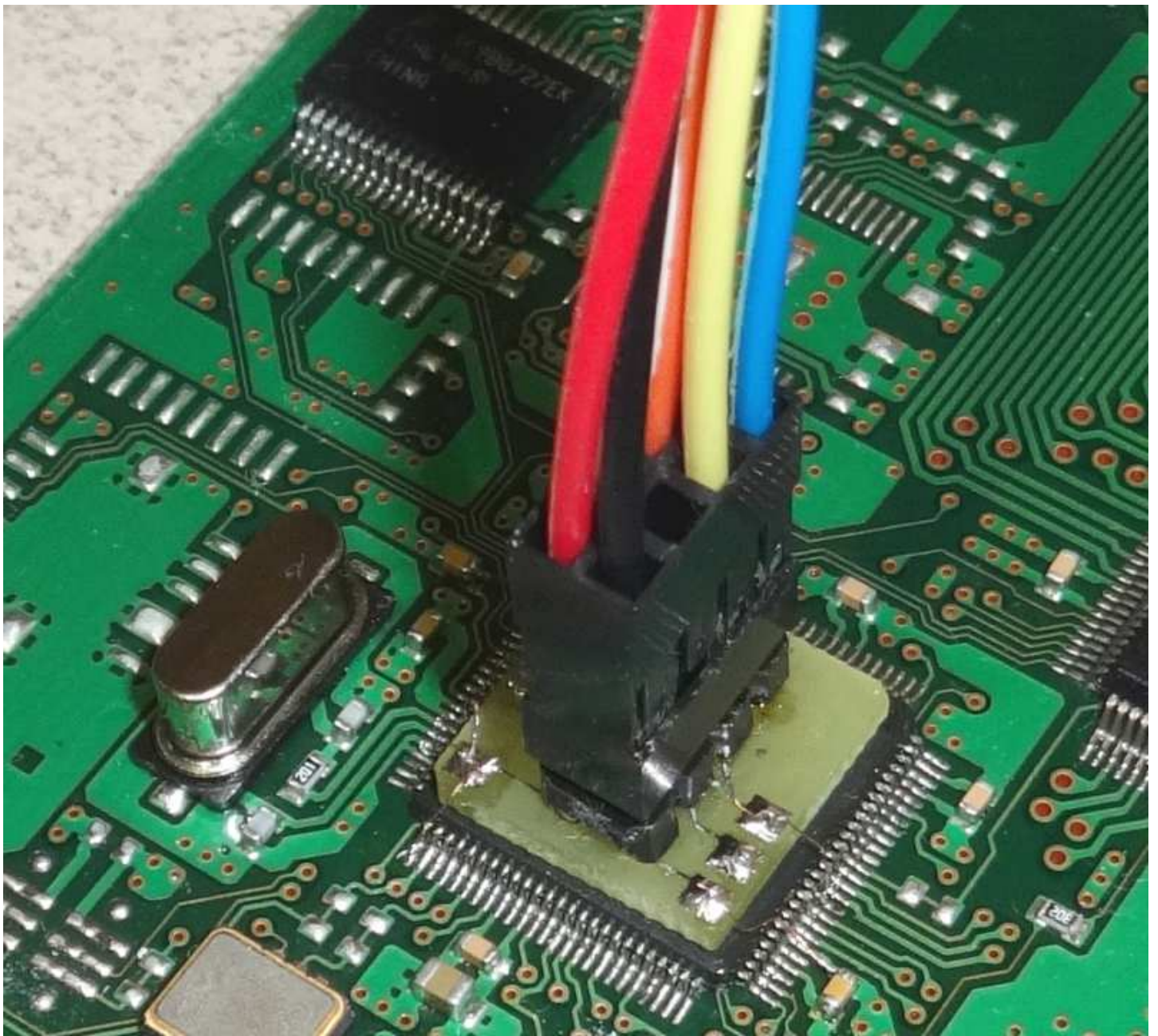

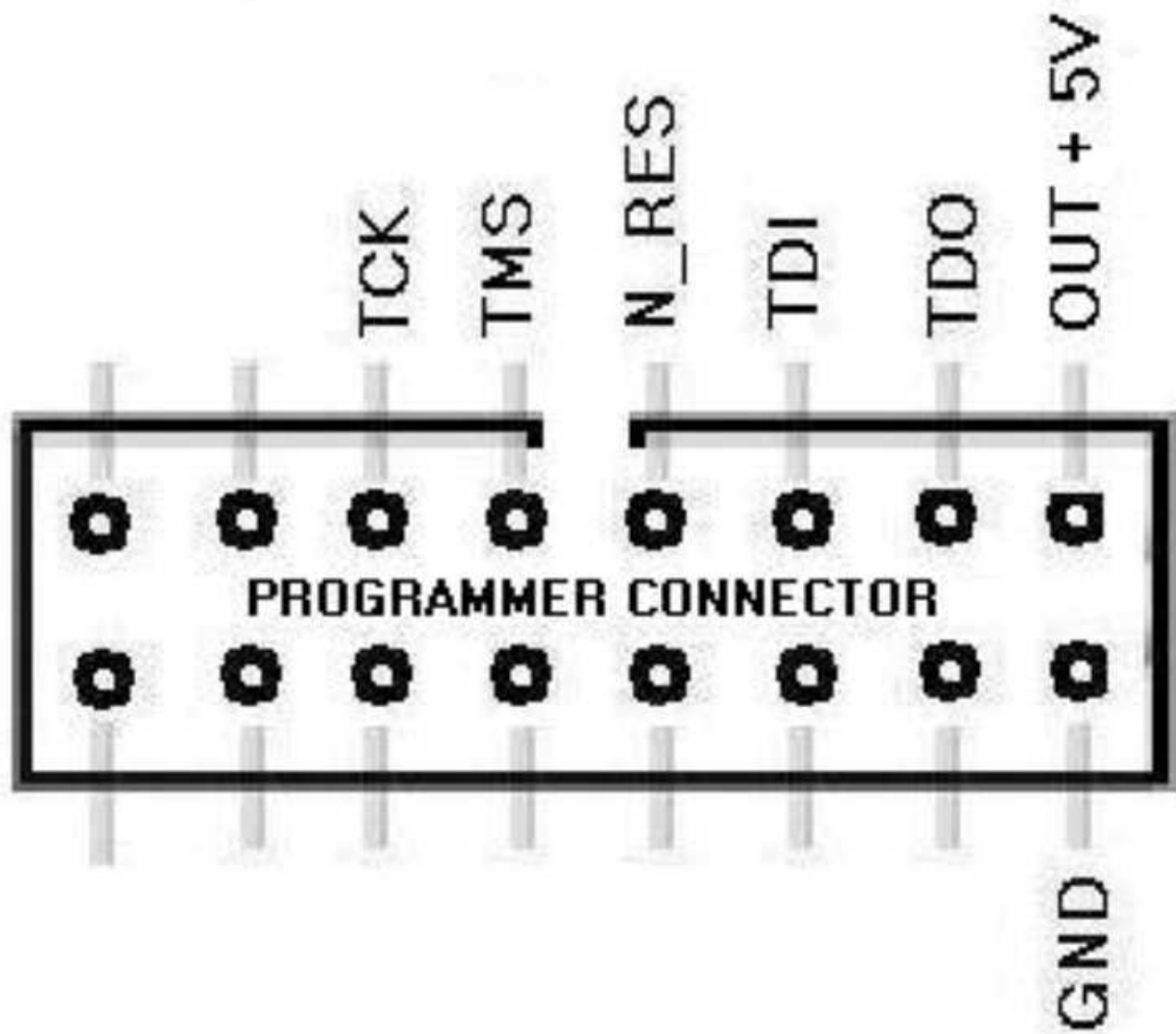

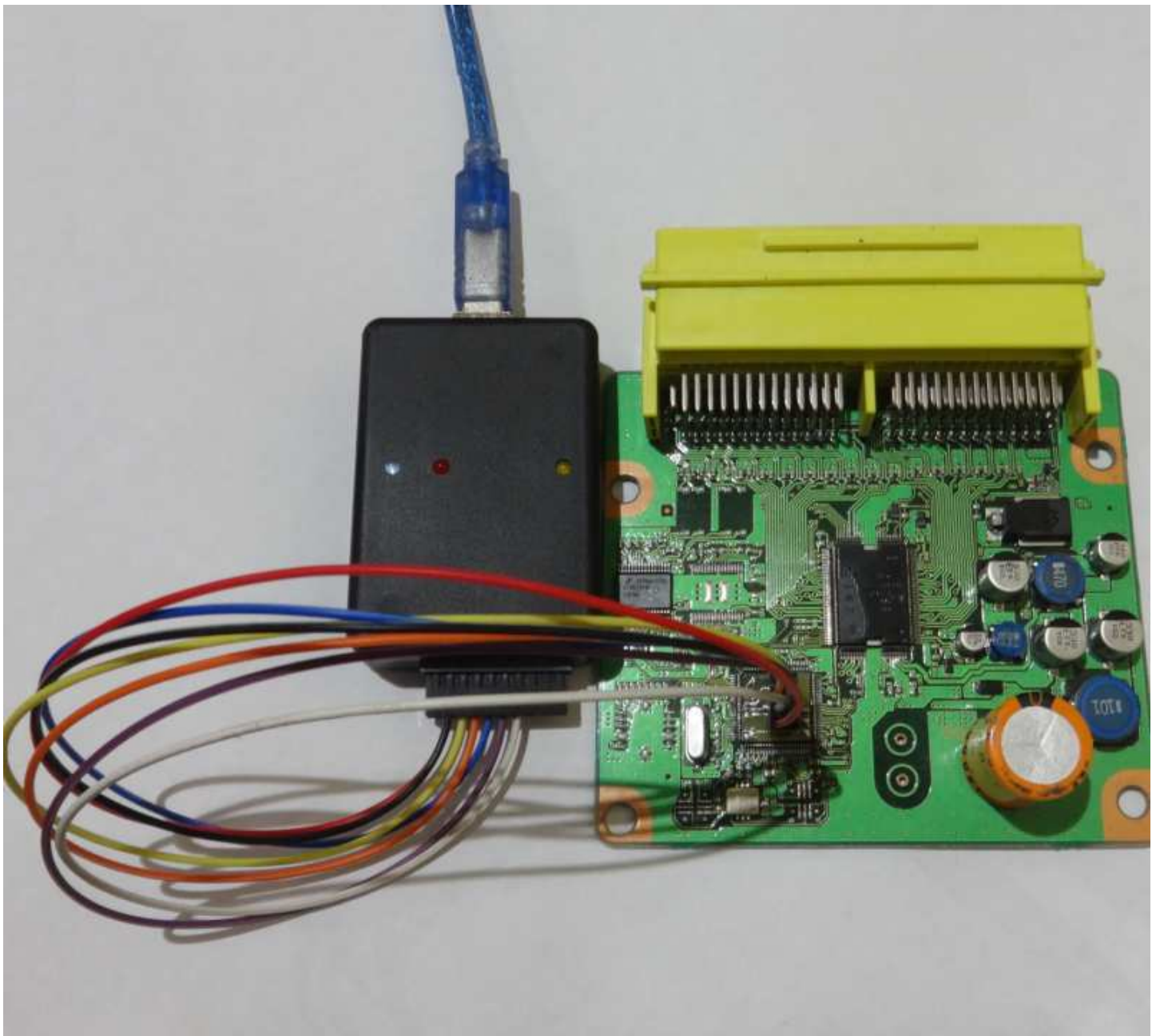





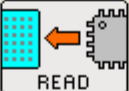

Renesas H8SX Programmer - [COM96]

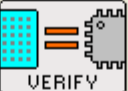
File Buffer Device Options Help

Device: Region:

Buffer size:

```

00000 | 52 35 46 36 31 37 32 35 FF FF FF FF FF FF FF FF | R5F61725.....
00010 | 30 31 FF FF 36 34 FF FF FF FF FF FF FF FF FF | 01..64.....
00020 | 31 30 30 FF FF FF FF FF 32 31 30 FF FF FF FF FF | 100.....210....
00030 | 4A 54 34 34 30 36 4B 20 20 20 30 34 30 33 33 30 | JT4406K 040330
00040 | 32 36 FF FF FF FF FF FF FF FF FF FF FF FF FF FF | 26.....
00050 | 30 31 30 31 34 35 34 35 31 30 31 32 30 31 FF FF | 01014545101201..
00060 | FF FF FF FF FF FF FF FF FF FF FF FF FF FF FF | .....
00070 | FF FF FF FF FF FF FF FF FF FF FF FF FF FF FF | .....

```

Time:	Message:
00:44:57	Reading device...
00:45:04	Canceled
00:45:10	Starting operation
00:45:11	Detected IDs: R5F61725
00:45:11	Reading device...
00:45:11	Successfully read 128 bytes, CRC32 = 97E0261A, speed 4,0 kB/s

Buffer window RENEPROG v1.12